

Film, Metallized Polyester Stacked, Commercial Grade, R82, 0.68 uF, 10%, 63 V, 85C, Lead Spacing = 5mm

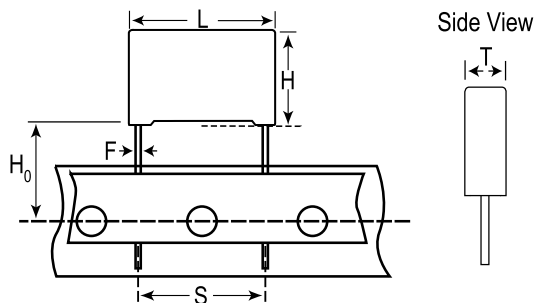

General Information	
Dielectric:	Metallized Polyester Stacked
Style:	Radial
Series:	R82
Features:	Pulse
RoHS:	Yes
Lead:	Wire Leads
Approvals:	AEC-Q200
AEC-Q200:	Yes
Miscellaneous:	Above 85C DC And AC Voltage Derating Is 1.25%/C

Dimensions	
L	7.2mm +0.3mm
H	9.5mm +0.1mm
T	4.5mm +0.1mm
S	5mm +/-0.4mm
H0	18.5mm +/-0.5mm
F	0.5mm +/-0.05mm

Specifications	
Capacitance:	0.68 uF
Capacitance Tolerance:	10%
Voltage DC:	63 VDC
Voltage AC:	40 VAC
Temperature Range:	-55/+105C
Rated Temperature:	85C
Dissipation Factor:	0.8% 1kHz, 1.2% 10kHz
Insulation Resistance:	7.3529 GOhms
Max dVdt:	160 V
Inductance:	7 nH

Packaging Specifications	
Packaging:	Ammo, 360x340x59mm, Box
Packaging Quantity:	1900

Statements of suitability for certain applications are based on our knowledge of typical operating conditions for such applications, but are not intended to constitute - and we specifically disclaim - any warranty concerning suitability for a specific customer application or use. This Information is intended for use only by customers who have the requisite experience and capability to determine the correct products for their application. Any technical advice inferred from this Information or otherwise provided by us with reference to the use of our products is given gratis, and we assume no obligation or liability for the advice given or results obtained.